

Installation Support • Soporte de instalación • Support d'installation

**Personal Assistance, Product Specs, & "How-to" Questions:**

Asistencia personal, especificaciones del producto y preguntas sobre "cómo hacerlo":

Aide personnelle, spécifications du produit et questions « pratique-pratiques » :

**1-800-PFAUCET (732-8238)**

**[pfisterfaucets.com/support](http://pfisterfaucets.com/support)**

Installation Videos Available  
Videos de instalación a disposición  
Vidéos d'installation disponibles



[pfisterfaucets.com/videos](http://pfisterfaucets.com/videos)

**▲ WARNING / ADVERTENCIA / AVERTISSEMENT**

To reduce the risk of injury or property damage, read all instructions before installing product. Wear safety goggles. Product must be installed in accordance with all state & local plumbing & building codes. Call a professional if you are uncertain about installing this product.

Para disminuir el riesgo de lesiones o daños a la propiedad, lea todas las instrucciones antes de instalar el producto. Utilice gafas de seguridad. El producto deberá instalarse de acuerdo con la normativa de plomería y construcción estatal y local. Llame a un profesional si no está seguro sobre cómo instalar este producto.

Pour réduire le risque de blessures ou de dommages, lire toutes les instructions avant d'installer l'appareil. Porter des lunettes de sécurité. Il faut installer l'appareil en respectant tous les codes de construction et de plomberie locaux et d'État. Appelez un professionnel si vous n'êtes pas certain de la façon d'installer cet appareil.

**Required Tools  
Herramientas necesarias  
Outils nécessaires**



Teflon Tape  
Cinta de teflón  
Ruban en téflon



Propane Torch  
Antorcha de Propano  
Torche de Propane



Phillips Screwdriver  
Destornillador de estrella  
Tournevis Phillips



Adjustable Wrench  
Llave ajustable  
Clé réglable



Pipe Wrench  
Llave de tubo  
Clé à Tube



Safety Goggles  
Anteojos de seguridad  
Lunettes de sûreté

**Additional Helpful Tools  
Otras herramientas útiles  
Outils supplémentaires utiles**



Flashlight  
Linterna  
Lampe-torche



Cloth  
Paño  
Chiffon

**Note  
Nota  
Remarque**



Plugs Not Included  
Tapones no incluidos  
Bouchons non inclus

**Parts in the Box • Piezas en la caja • Pièces dans la boîte**

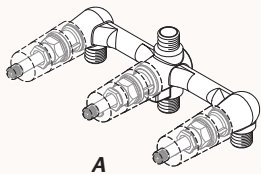

A



B



C

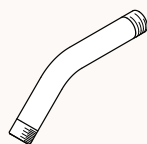

D



E (x3)



F (x3)



G (x3)  
or  
ou



H (x3)



J (x4)



K (x3)



L



Supplied Hex Wrench  
Proveído Llave hexagonal  
Fourni Clé hexagonale

**1 Turn Off Water Supply • Cierre el suministro de agua • Couper l'alimentation en eau**

Locate the water supply inlets & shut off the water supply valves. These are usually found near the water meter. If you are replacing an existing unit, remove the old unit & clean mounting surface thoroughly.

Ubique las entradas del suministro de agua y cierre las válvulas de suministro. Estas se encuentran generalmente cerca del medidor de agua. Si reemplaza una unidad existente, retírela y limpie completamente la superficie de montaje.

Repérez les entrées d'alimentation d'eau et fermez les robinets d'arrêt. Ils sont normalement trouvés près du compteur d'eau. Si vous remplacez un appareil existant, enlevez le vieil appareil et nettoyez soigneusement la surface de montage.

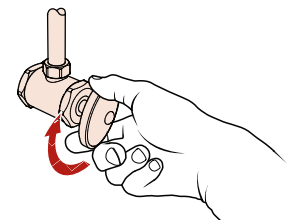

## 2 Prepare for Installation

Preparación para la instalación

Préparez pour installer

No Tools Required for This Step  
No se necesitan herramientas para este paso  
Aucun outil n'est nécessaire pour cette étape

No Parts Required for This Step  
No se necesitan piezas para este paso  
Aucune pièce nécessaire pour cette étape

### 2A Work Area Inspection

Inspección del área de trabajo

Contrôle de la zone de travail

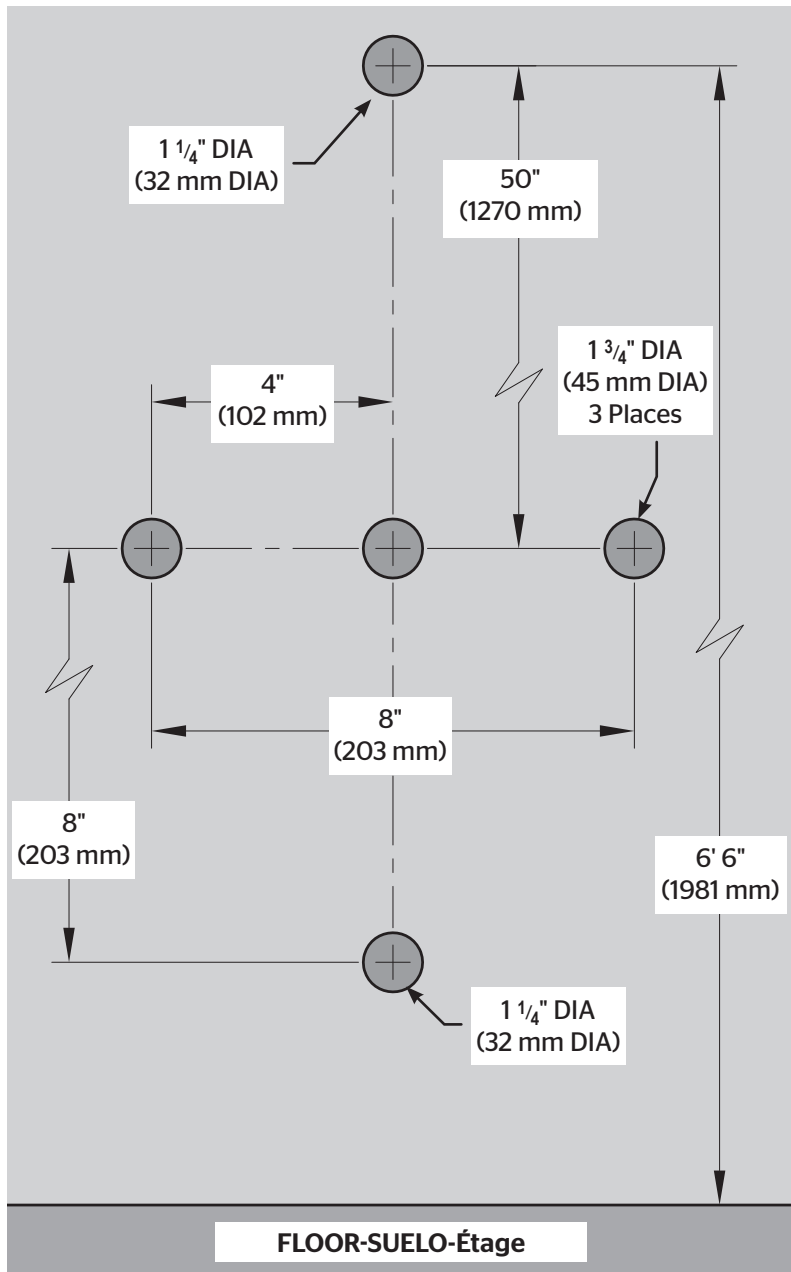

### 2B Valve Installation-Shallow Wall

Instalación de la válvula-Pared poco profunda

Installation de la vanne-Mur peu profond

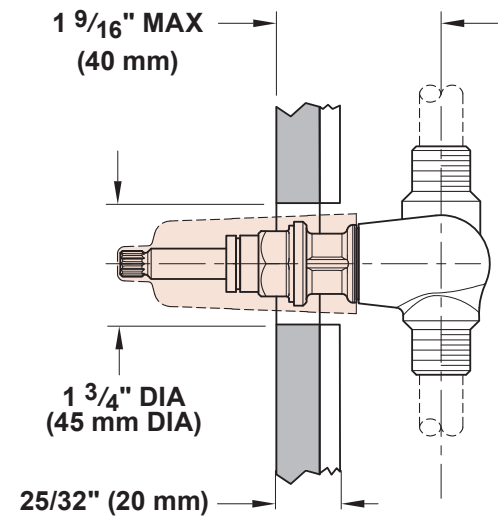

### 2B Valve Installation-Deep Wall

Instalación de la válvula-Pared profunda

Installation de la vanne-Mur profond

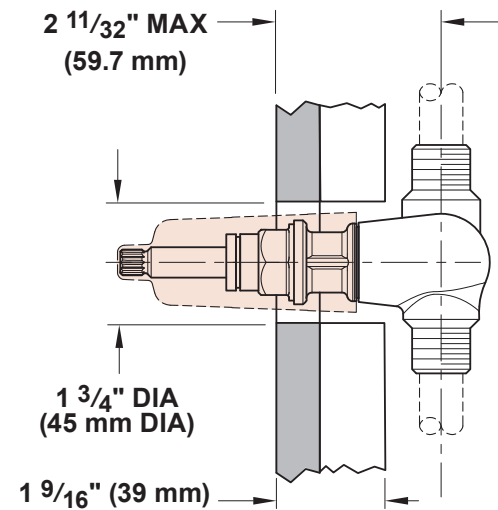

### 3 Supply Connections

Conexiones de la fuente

Raccordements d'alimentation

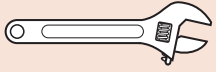

Adjustable Wrench  
Llave ajustable  
Clé réglable



Propane Torch  
Antorcha de Propano  
Torche de Propane



Pipe Wrench  
Llave de tubo  
Clé à Tube

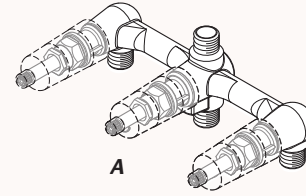

A

#### 3A Option1: Iron Pipe Installation

Opción 1: Instalación de Tubería de Hierro

Option1: Installation de Tuyaux de Fer

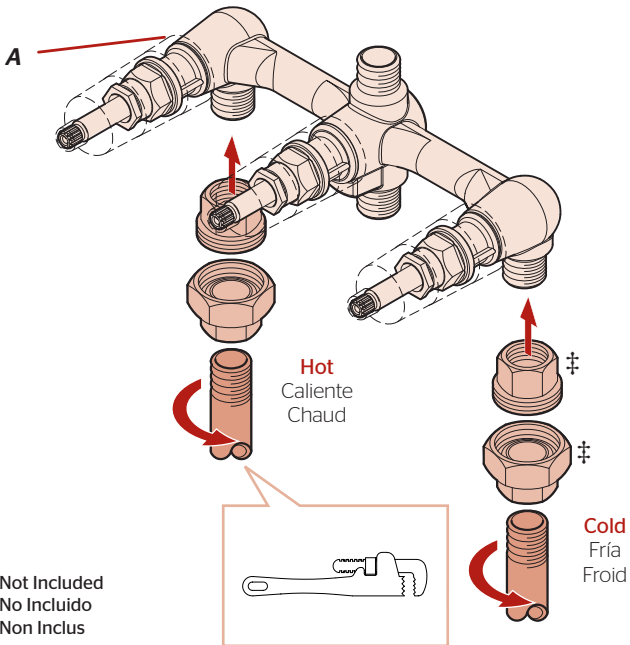

#### 3B

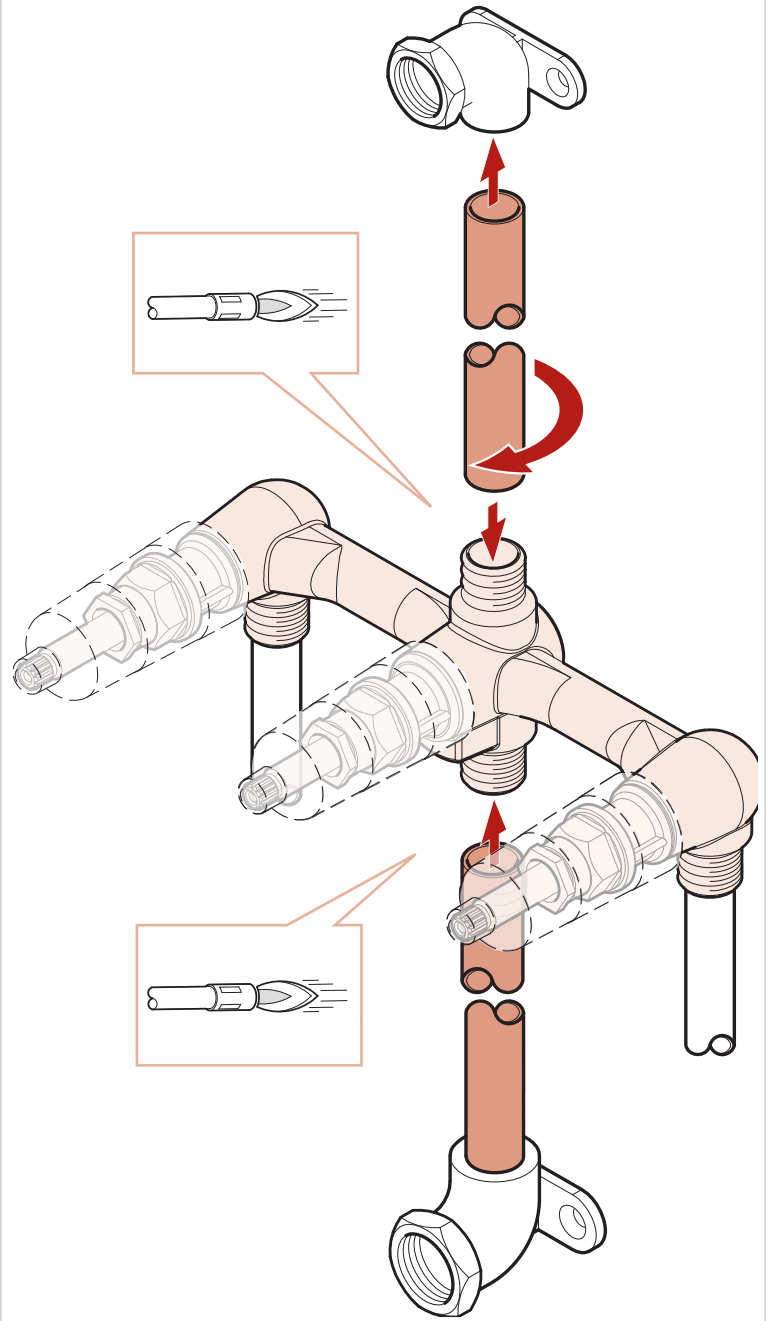

#### 3A Option2: 1/2" Copper Pipe Installation

Opción 2: Instalación de Tubería de cobre de 1/2"

Option 2: Installation de tuyau de cuivre de 1/2"

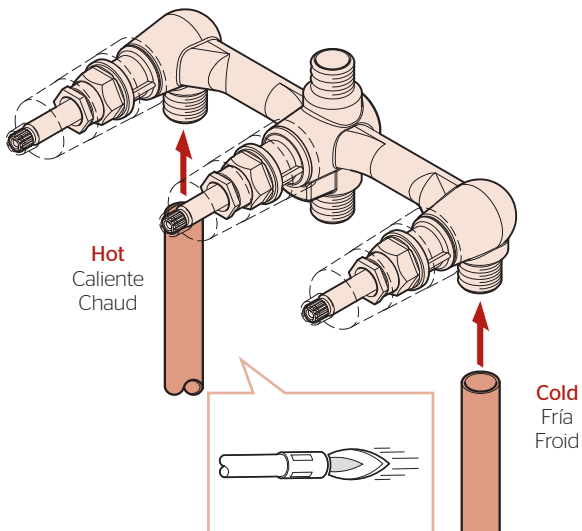

## 4 Pressure Testing the Valves

### Prueba de Presión de Válvulas

### Test de Pression de Valves

No Tools Required for This Step  
No se necesitan herramientas para este paso  
Aucun outil n'est nécessaire pour cette étape



Plugs Not Included  
Tapones no incluidos  
Bouchons non inclus

#### 4A

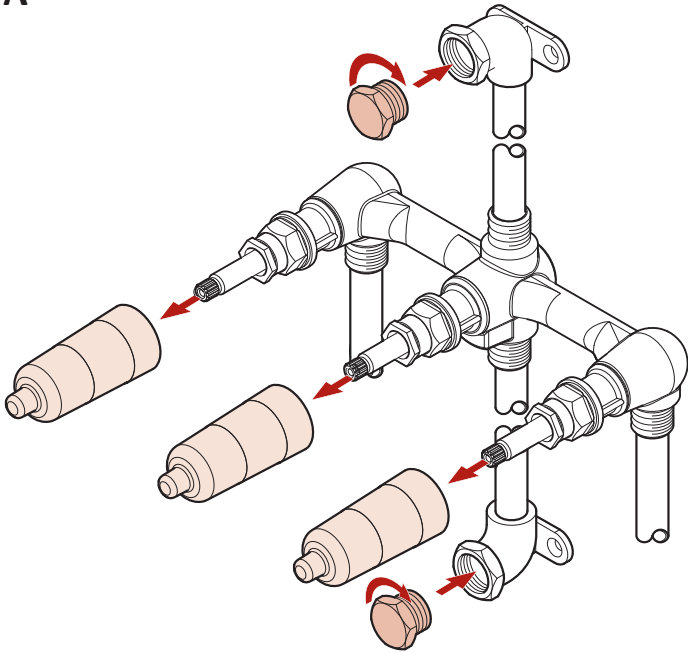

#### 4B

Open  
Abierta  
Ouverte

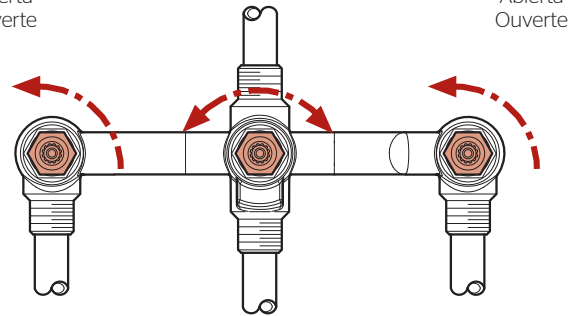

Open  
Abierta  
Ouverte

Turn to full ON position and check connections for leaks.  
Turn to full OFF position and check for leaks from the outlets

Gire los vástagos de las válvulas a la posición completamente abierta y revise todas las conexiones para ver si hay fugas. Gire los vástagos de las válvulas a la posición cerrada y verifique que no haya fugas de las salidas.

Faites tourner les tiges des robinets d'eau jusqu'à ce qu'elles soient dans la position voulue et vérifiez tous les raccords pour vous assurer qu'ils ne fuient pas. Faites tourner les tiges des robinets d'eau jusqu'à ce qu'elles soient fermées et vérifiez si les sorties ne fuient pas.

#### 4C

Remove slowly  
Retire lentamente  
Retirer lentement

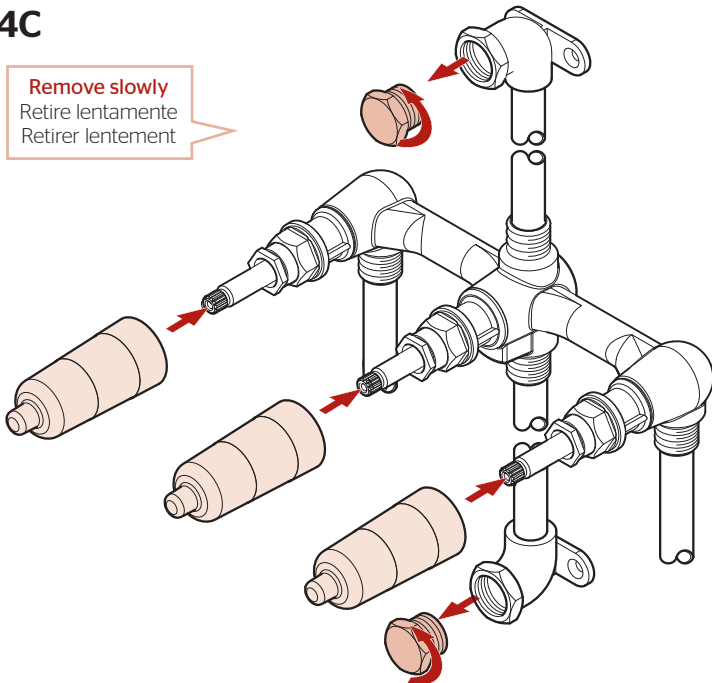

# 5 Shower Arm and Spout Installation

## Instalación del Brazo de Ducha y el Surtidor

### Installation du Bas de Douche et le Bec



Teflon Tape  
Cinta de teflón  
Ruban en téflon

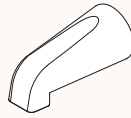

C



B

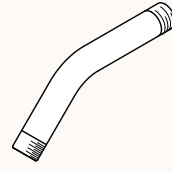

D



J

5A

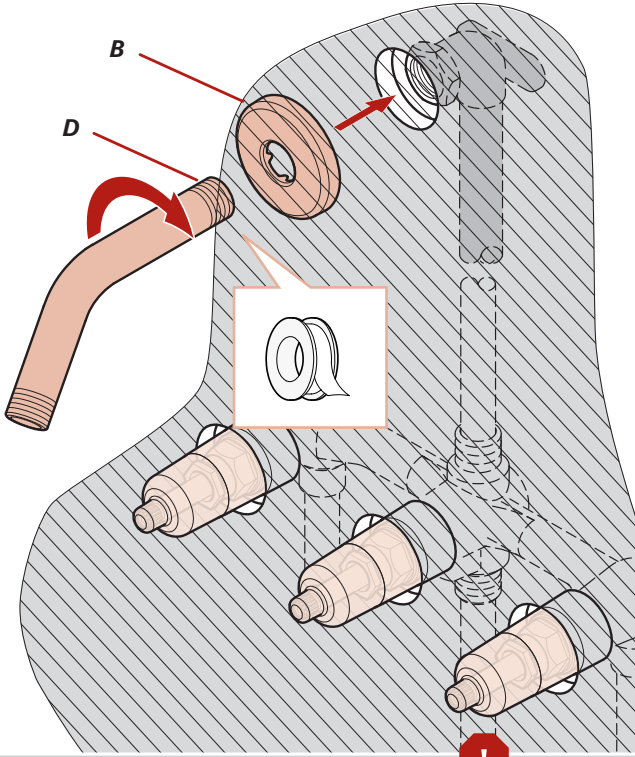

5B

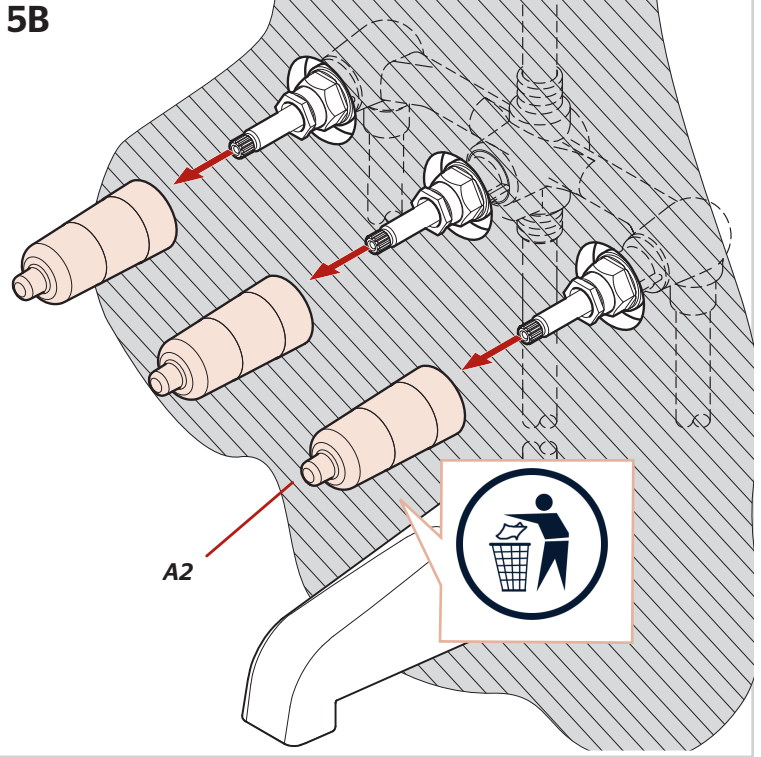

**5C Option 1: Copper Pipe**  
Opción 1: Tubo de Cobre  
Option 1: Tuyau de Cuivre

**Chamfer and deburr**  
Chafilán y desbarbar  
Chanfrein et ébarber

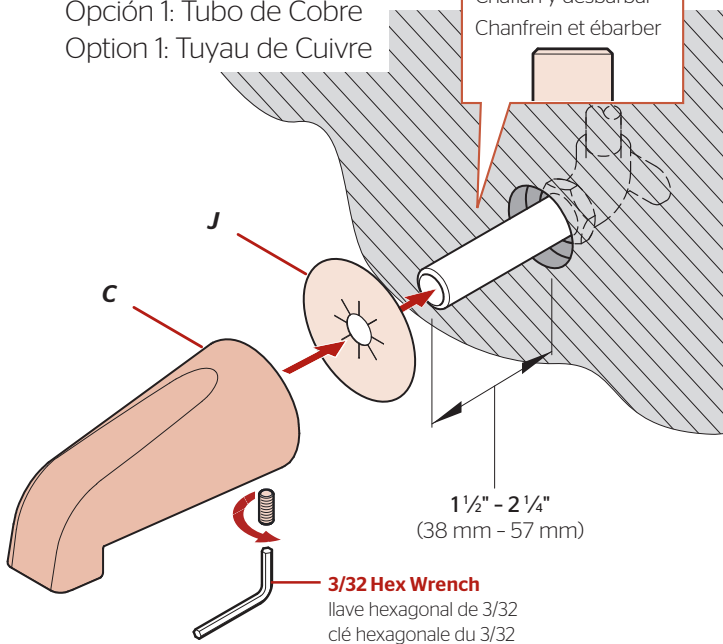

**5C Option 2: Threaded Pipe**  
Opción 2: Tubo Roscado  
Option 2: Tuyau Fileté

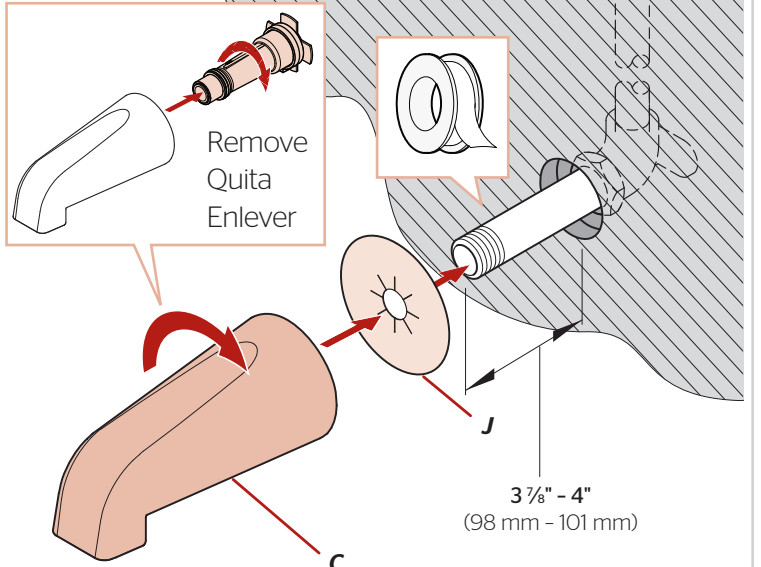

## 6 Shower Flange and Handles Installation

Instalación de Rebordes y las Manijas

Installation du Brides et Poignée



Teflon Tape  
Cinta de teflón  
Ruban en téflon



Phillips Screwdriver  
Destornillador de estrella  
Tournevis Phillips



E (x3)



F (x3)

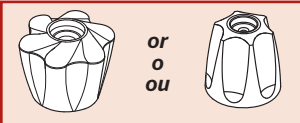

or  
o  
ou  
G (x3)



H (x3)



J (x3)



K (x3)

6A

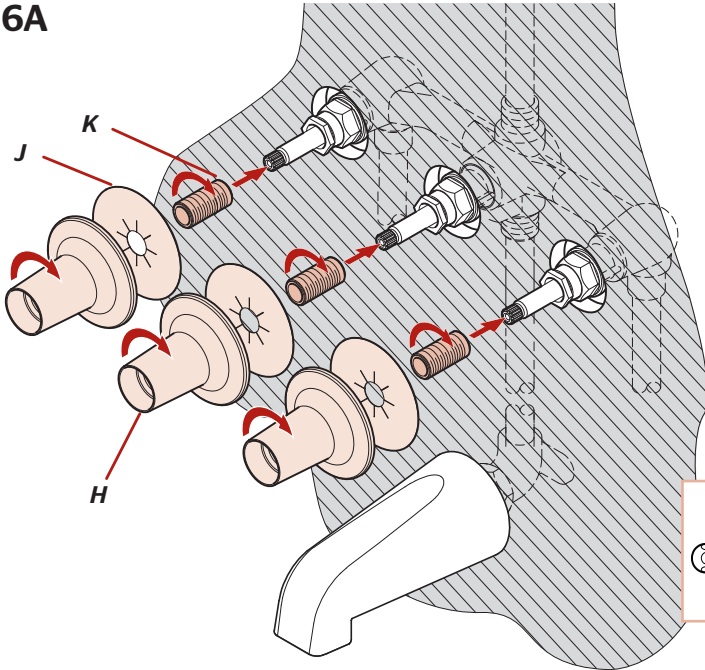

6B

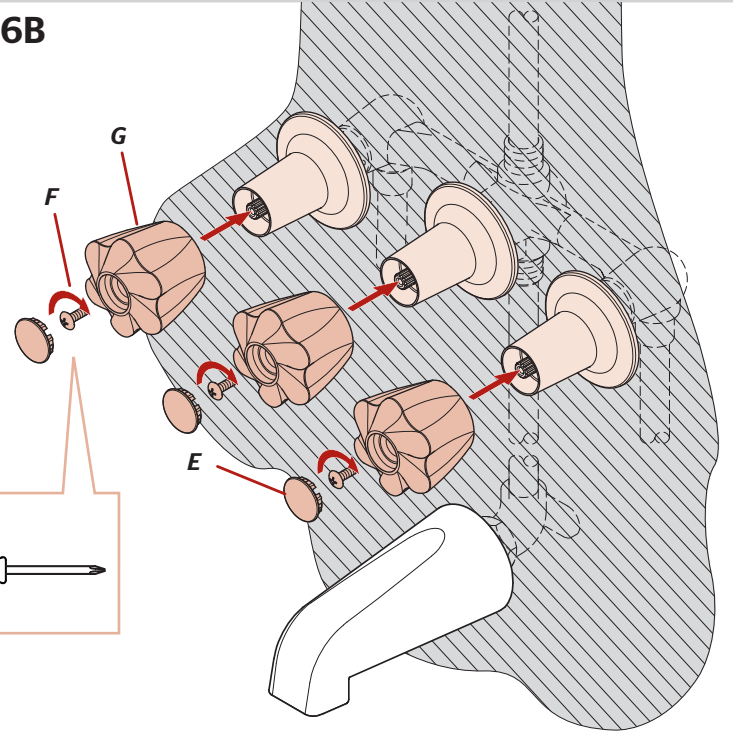

## 7 Turn On Water

Active el suministro de agua

Ouvrez l'eau

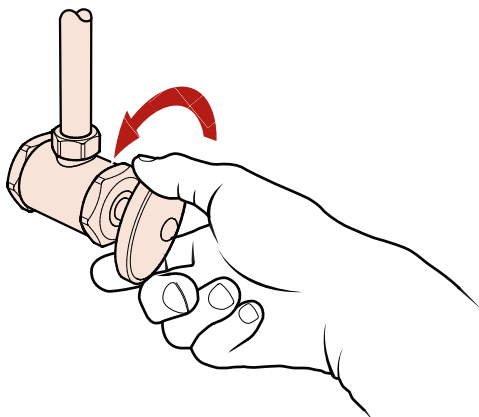

**Turn on your water supply & check for any leaks.**

Active el suministro de agua y revise si hay fugas.

Rétablissez l'alimentation en eau et vérifiez s'il y a des fuites.

## 8 Flush and Install Showerhead

Enjuague y instalar Ducha

Vidangez et installez la Douchette

No Tools Required for This Step  
No se necesitan herramientas para este paso  
Aucun outil n'est nécessaire pour cette étape



L

8A

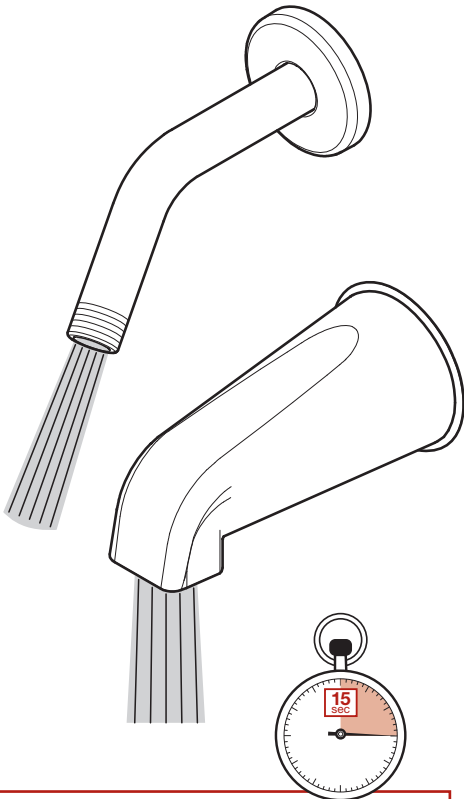

**Allow full hot & full cold water to run for at least 15 seconds each.**

Deje correr el agua caliente y fría durante al menos 15 segundos cada una.

Permettez à l'eau chaude et l'eau froide de couler au moins 15 secondes chacun.

8B

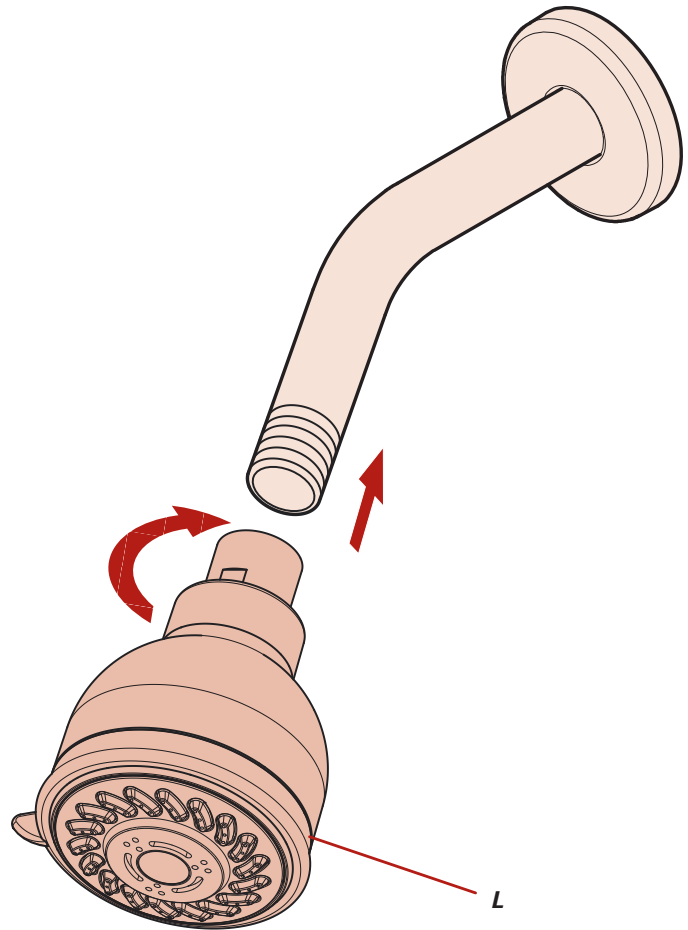

L

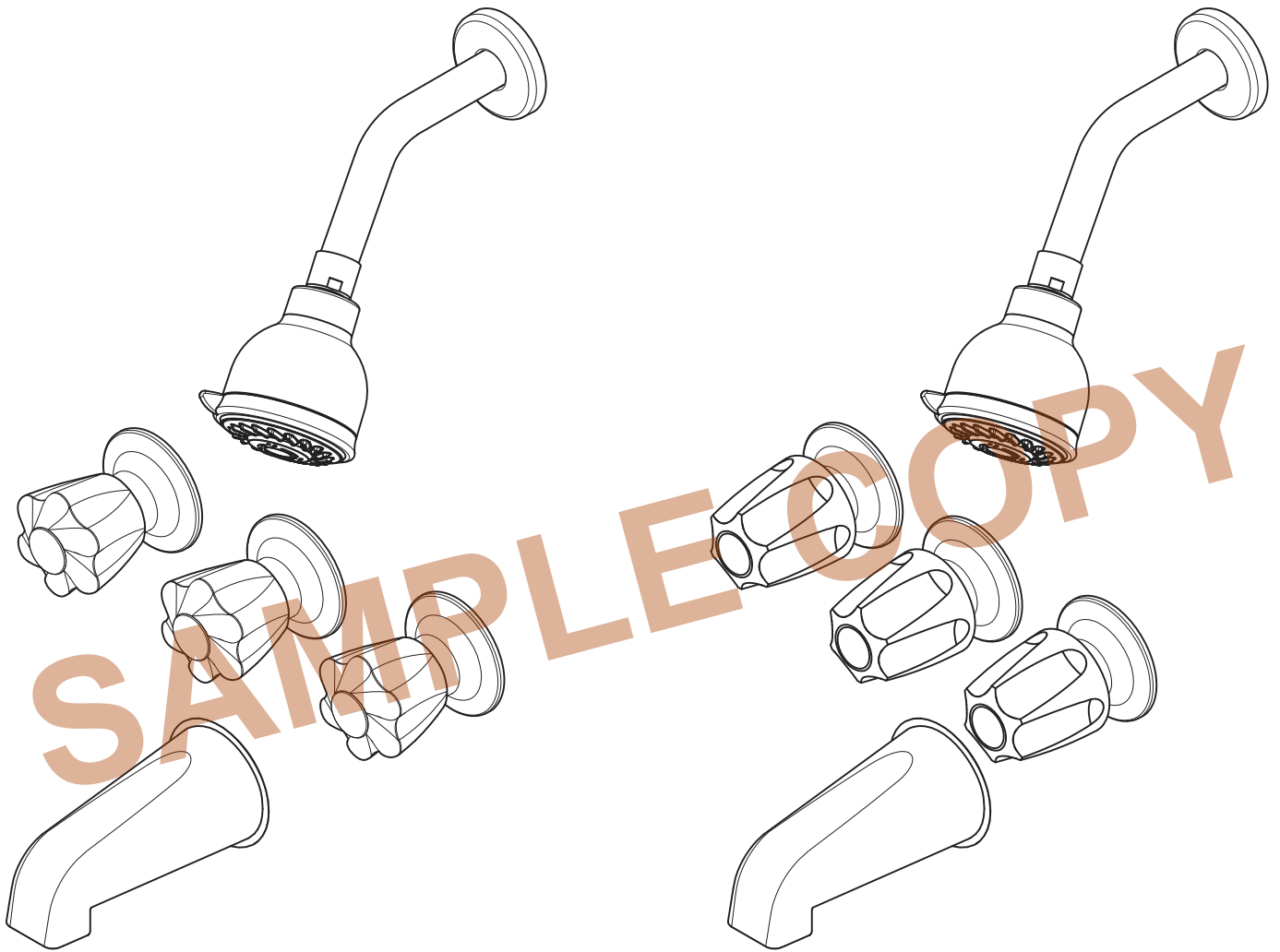

**For Additional Installation Help:**  
Para la instalación adicionales de ayuda:  
Pour aider à l'installation supplémentaires:

**Pfister**<sup>®</sup>

**1-800-PFAUCET (732-8238)**  
**[pfisterfaucets.com](http://pfisterfaucets.com)**